

M3504B

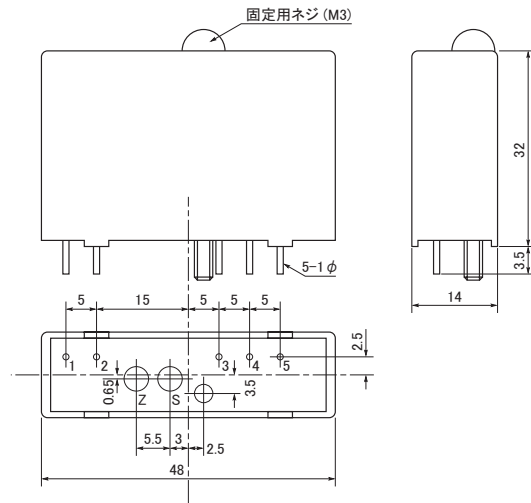

ピン配列	
1	INPUT +
2	INPUT -
3	OUTPUT +
4	OUTPUT COM.
5	POWER +15V

単位: mm