

M3700B

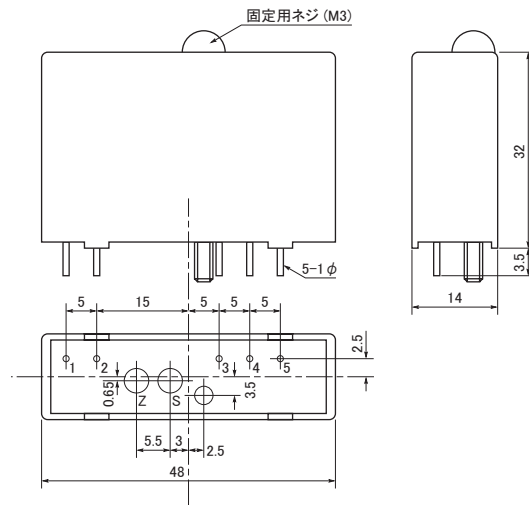

ピン配列	
1	OUTPUT+
2	OUTPUT-
3	INPUT+
4	INPUT COM.
5	POWER +15V

単位:mm