

MS5510

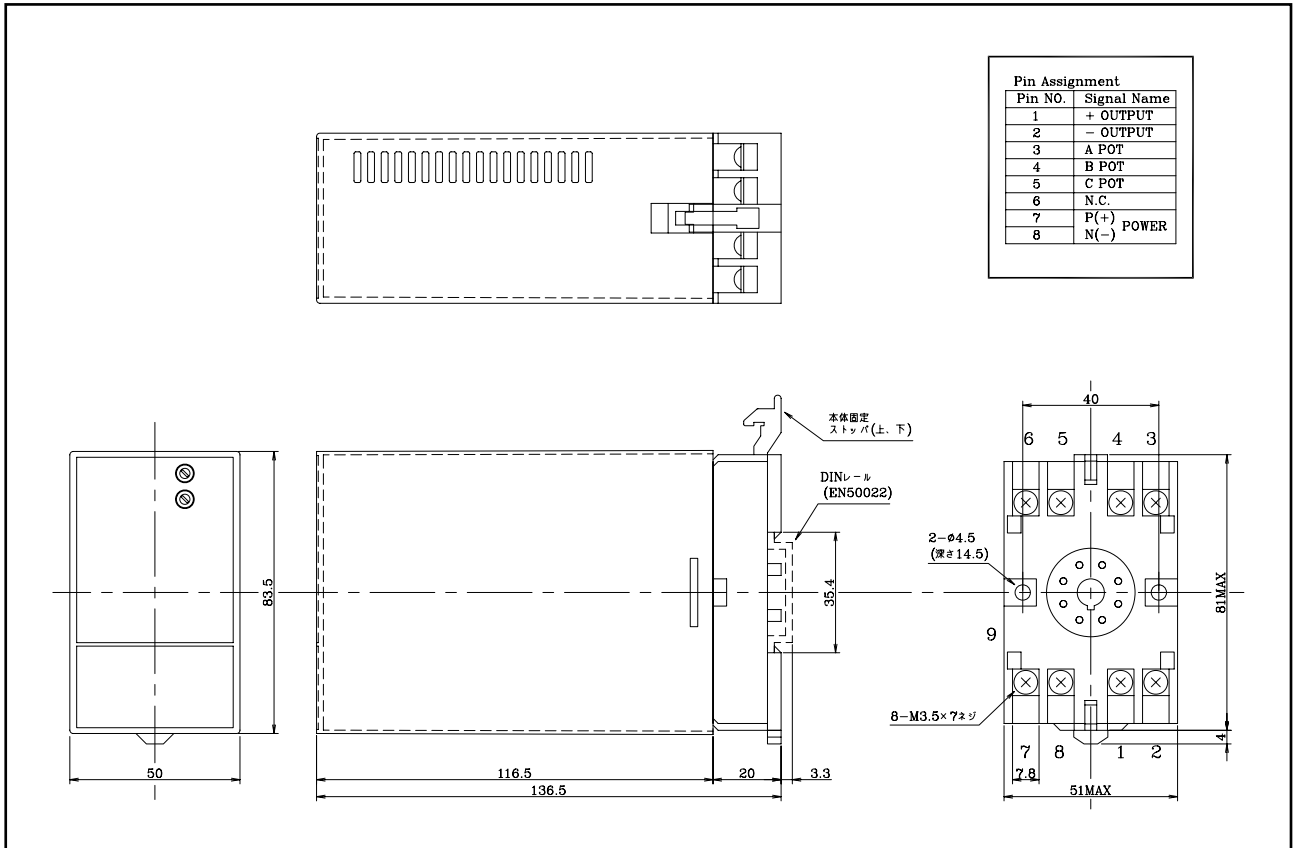

単位:mm