

MS5544

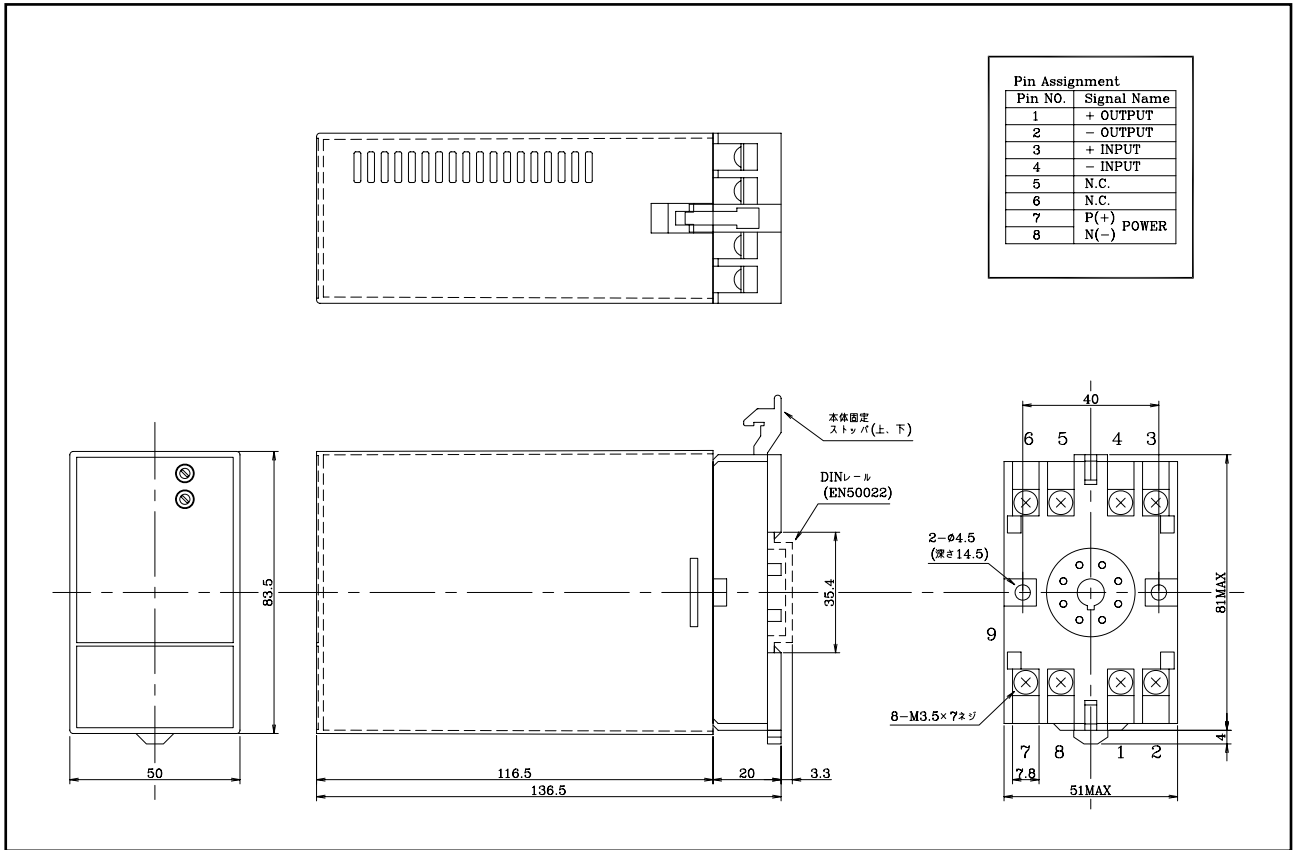

単位:mm