

User's Manual MS3104

Terminal Block Type High-Level Signal Conditioner with Isolated Dual Output

Document No: MQDDK-111130-4

Rev. 1.80

Thank you very much for employing MTT products.

Upon receipt of the product(s), please check the affixed label to make sure that the specifications shown therein conform to your requirements. If you find any discrepancies and/or any damage on the product(s), please contact MTT or its local representatives.



You can be assured that all the MTT products are manufactured according to the strict quality control standards.

1. Introduction

For proper operation of the instrument(s), we recommend that you carefully read this manual prior to operation. The manual should be retained for future reference. Please also refer to the relevant product specification sheet.

2. For Safe Operation

Be sure to observe the following safety clauses in your operation of the instrument(s). MTT cannot undertake any responsibility and guarantee for any damage and/or loss caused by improper operation contrary to or neglecting these clauses.

 WARNING	Disregard of this clause may cause fatal harm or serious bodily injury due to fire or electric shock.
 CAUTION	Disregard of this clause may cause bodily harm or damages to nearby objects due to electric shock or other accidental happenings.

The following safety symbols are used on the instrument and in this document:

 Equipment protected throughout by double insulation or reinforced insulation

 Functional earth terminal (Do not use this as a protective earth terminal.)

WARNING

- All electrical connections must be made to the terminal blocks of the instrument. All connections and disconnections must be made with no power applied to the instrument. Otherwise, electric shock may result.
- Do not disassemble or modify the instrument, and do not replace the power fuse. Otherwise, fire or electric shock could result.
- Do not allow any foreign matter (metal chips, water, liquid, etc.) to get into the instrument. Should any foreign matter enter the instrument, immediately unplug the power cable, and contact MTT or its distributor.
- When the instrument is used for applications that require higher reliability and safety, such as transportation, communication, power generation control and medical equipment, special consideration should be taken in safety design to prevent such equipment from malfunctioning as a whole system.
- Do not operate the instrument in an explosive atmosphere containing flammable vapors, gases or dusts. Otherwise, an explosion may result.
- Do not place any combustible materials in the vicinity of the instrument.
- Because no power switch is provided on the instrument, the power supply of the instrument cannot be turned off on the instrument side. So, be sure to provide a power circuit breaker for the power source of the instrument. Note that the breaker should be installed in a location close to the instrument for the convenience of operation. And the breaker should be marked as a "disconnecting device" for the instrument.

CAUTION

- Use the instrument within the operating conditions described in the published product specification. Failure to do so may cause fire or damage to the instrument.
- Avoid operating the instrument in locations where extreme temperature changes can cause condensation. Otherwise, it may be damaged.
- Avoid operating or storing the instrument in locations where corrosive gases are present or chemical solvents may splash.
- For the sake of safety, installation and wiring must be performed by qualified personnel with expertise in electronics, electricity or instrumentation engineering.

3. Precautions

Be sure to observe the following precautions to ensure proper operation of the instrument(s). If these precautions are disregarded, the performance of the instrument(s) cannot be guaranteed.

For Handling:

- This is a precision instrument. Do not drop or throw the instrument.
- This product contains electronic parts. Do not splash water on the product and do not dip it in water. For installation, select a place where no condensation occurs.
- Avoid storing or installing the instrument in locations subject to direct sunlight, high temperature, dust, high humidity or vibration.

On Power Supply:

Check the power rating on the specification label of the unit to ensure you use the correct power supply.

- Rating 100 to 240V AC, 50 to 60Hz, approx. 6.5VA (Input range: 85 to 264V AC, 47 to 63Hz)
- Rating 24V DC, approx. 1.6W (Input range: 24V DC \pm 10%)
- Rating 110V DC, approx. 2.5W (Input range: 90 to 121V DC)
- Rating 12V DC, approx. 1.3W (Input range: 12V DC \pm 20%)

For Installation:

- The instrument is intended for indoor installation.
- Refer to section 8 "Mounting / Demounting" to install the unit on a DIN rail.
- Operating environmental conditions:
 - Temperature range: -5 to 55°C
 - Humidity: 5 to 90% RH
 - Altitude up to 2000 meters
- Do not block the vents in the instrument.
- Be careful not to ground the minus (-) terminal of the power supply.
- Use an independent grounding or alternative grounding which does not allow current to flow in.
- The instrument should be installed as shown in the sketch below, namely, in such a position that the label on the front panel is readable in the right direction.
- For effective heat dissipation, allow a space of at least 100 mm above and below the unit. When units are used in multiple stacks, they should be spaced at least 130 mm apart from each other. If the required minimum space is not available, take appropriate heat protection measures by, e.g., placing a partition between the units. Provide a ventilation hole or install a cooling fan to improve airflow. Keep adequate working space in front of and on both sides of the unit.

Installation Position

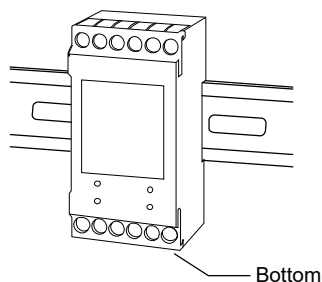

Typical Installation Example

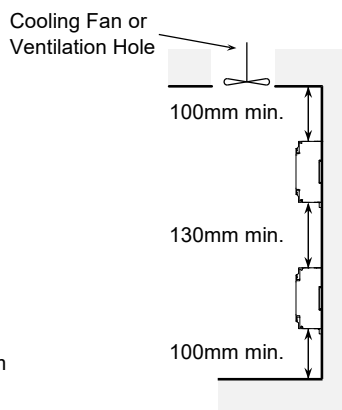
**On Wiring:**

- Wiring connections to the instrument should be made to the terminal blocks. For terminal assignments, refer to sections 5 and 6. The recommended screwing torque is 0.8 to 1.0 Nm.
- For your safety, do not make any electrical connections or disconnections with power supplied to the instrument. Make sure that all terminal screws are properly tightened each time you finish the tightening.
- For lead wires, use a highly flexible stranded conductor. The recommended nominal cross-section of the lead wire conductor is 0.5 to 2.0 mm².
- The connection of the lead wire to the terminal block should be made with the insulated crimp terminal attached to the end of the wire. Without the insulation, short circuit or electric shock may occur. The recommended thickness of the crimp terminal is 0.7 to 1.0 mm.

Note that only up to two (2) crimp terminals can be connected to one (1) terminal screw. In this case, the thickness of the crimp terminal should be not greater than 0.8 mm.

To Avoid Erroneous Measurements:

- In order to reduce the influence of noise, the input/output wire and power supply wire should not be used in a same bundle or same conduit. They should be installed separately with a minimum distance of 200 mm.
- Avoid wiring the signal lines in the vicinity of equipment generating magnetic fields or electromagnetic waves, such as electric motors and large-scale transformers. If inevitable, anti-noise measures such as employment of shielded wires are indispensable.
- At least 30 minutes of warm-up is required prior to operation.
- Any sensor or equipment to be connected to the instrument should be selected in consideration of the input/output impedance of the same. (For detailed specifications, refer to section 4 or the relevant product specification sheet that can be downloaded from our website at <https://www.mtt.co.jp>.)

Special Notes for CE Marking:

- The instrument is designed and manufactured to conform to the following EMC and Low Voltage Directives:
 - EMC Directive (2014/30/EU)
 - Standard conformity: EN61326-1:2013 Class A
 - Low Voltage Directive (2014/35/EU)
 - Standard conformity: IEC61010
 - EN61010-1:2010/A1:2019
 - Overvoltage Category: II
 - Pollution Degree: 2
- The instrument must be installed in a control panel.
- The instrument maintains basic insulation between input and output, and between output and GND. Prior to installation, check that the insulation class of the instrument satisfies your system requirements.
- When the instrument is installed in a control panel, the measures to be taken for CE marking conformity may vary with the type of devices connected, wiring to the instrument or structure of the control panel. Therefore, you should check that the control panel as an overall system conforms to the CE marking regulations.

4. About the Product

The MS3104 converts a DC voltage or current input into two isolated DC outputs.

Features:

- High dielectric strength of 2,000 VAC between input, [output 1, output 2], and [power, ground].
- The power unit can deliver AC power ranging from 85 to 264V steplessly without switching to meet varied power requirements.
- Compact and easy-to-use design with integrated terminal blocks
- Drop-proof terminal screws for ease and safety of installation
- Fuse installed in the power line as standard.

Specifications

Input Resistance	Voltage input: 1M Ω min. with or without power. Current input: 4 to 20mA DC: 250 Ω (standard) 2 to 10mA DC: 250 Ω 1 to 5mA DC: 100 Ω 0 to 20mA DC: 250 Ω 10 to 50mA DC: 10 Ω
Allowable Input Voltage	Voltage input: 30V DC max., continuous. (standard for a span up to 10V) Current input: 40mA DC max., continuous. (standard for 4-20mA)
Allowable Output Load	Voltage output: 1V span and up: 2mA max. 10mV: 10k Ω min. 100mV: 100k Ω min. Current output: Single current output: 750 Ω max. (for 4-20mA output) Dual current output: Output 1: 550 Ω max. (for 4-20mA output) Output 2: 350 Ω max. (for 4-20mA output)
Zero Adjustment	Approx. $\pm 5\%$ of span. (Adjustable by the front-accessible trimmer.)
Span Adjustment	Approx. $\pm 5\%$ of span. (Adjustable by the front-accessible trimmer.)
Accuracy Rating	Better than $\pm 0.1\%$ of span (at 25°C $\pm 5^\circ$ C)
Temperature Effect	Better than $\pm 0.2\%$ of span per 10°C change in ambient.
Response Time	85ms max. (0-90%) with a step input at 100%.
Insulation Resistance	100M Ω min. (@ 500V DC) between input, output 1, output 2, power, and ground.
Dielectric Strength	Input / [Output 1, Output 2] / [Power, Ground]: 2000V AC for 1 minute (Cutoff current: 0.5mA) Power / Ground: 2000V AC for 1 minute (Cutoff current: 5mA) Output 1 / Output 2: 500V AC for 1 minute (Cutoff current: 0.5mA)
Surge Withstand Capability	Tested as per ANSI/IEEE C37.90.1-1989.
Storage Temperature	-10 to 60°C

5. External Dimensions & Terminal Assignments

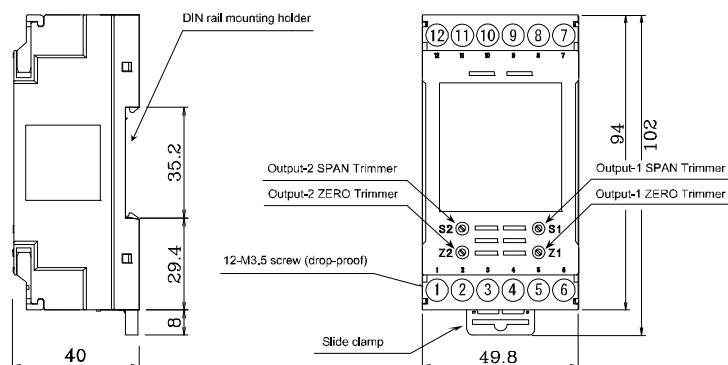

6. Terminal Connection Diagram

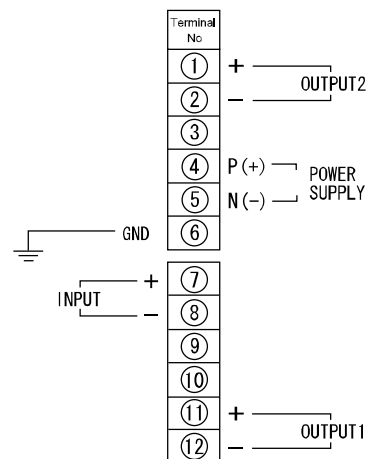

7. Terminal Connection

The following steps should be taken prior to the connection.

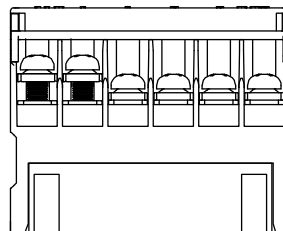

(1) Loosen the terminal screw.

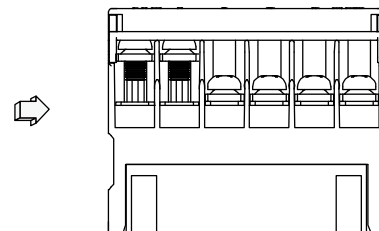

(2) Insert the tip of a screwdriver bit beneath the washer and push it up to make ample room to receive a cable.

8. Mounting / Demounting

Mounting on a DIN rail

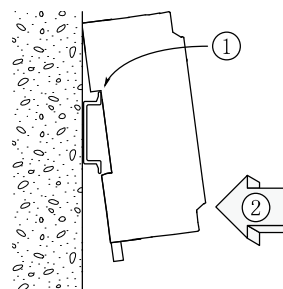

Hold the unit with the slide clamp facing down. Hook the upper edge of the cavity in the rear of the unit over the upper blade of the rail (1), then push the lower part of the unit against the lower blade of the rail so as to make the slide clamp engaged firmly with the rail (2).

Demounting

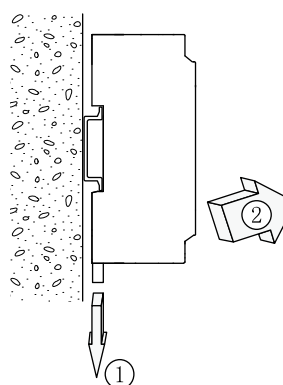

Push the slide clamp downward with a flat-head screwdriver bit or the like (1), and pull the lower part of the unit toward you (2).

9. Adjustment

Since the unit is precisely factory-adjusted before shipment, no further adjustment is needed at the user's side. Adjustment of signal conditioners requires technical expertise and fine craftsmanship. We recommend that you use adjustment service of MTT to save costs and ensure accuracy. Please contact MTT or its local representatives. Just for your reference, the adjustment procedure is described below.

9-1. Preparation

- Refer to sections 5 and 6 for terminal assignments.
- The wiring work should be performed with no power applied to the instrument.
- Wiring should be connected to the terminal blocks.
- At least 30 minutes of warm-up is required before adjustment.
- The accuracy of measuring equipment to be used for calibration must be much higher than that of the instrument to be adjusted.
- The ZERO and SPAN Trimmers for output 1 work on both the output 1 and output 2, whereas those for output 2 only work on the output 2.

9-2. Adjustment Procedure

- (1) Connect the unit as illustrated below.
- (2) Adjust the voltage or current source to generate a signal equivalent to 0%* of the input range of the unit.
- (3) Slowly turn the ZERO Trimmer to get 0%* output while applying 0%* input as above.
- (4) Adjust the voltage or current source to generate a signal equivalent to 100% of the input range of the unit.
- (5) Slowly turn the SPAN Trimmer to get 100% output while applying 100% input as above.
- (6) Repeat steps (2) through (5) until zero and span are precisely adjusted.
- (7) Follow the same procedure for the output 2.
- (8) Adjust the voltage or current source to generate 25%, 50% and 75% of the input signal range of the unit and record the values of output signals to confirm they are linearly proportional.

* For 0 to 20mA output, 0% should be interpreted as 0.5%.

Wiring Diagram

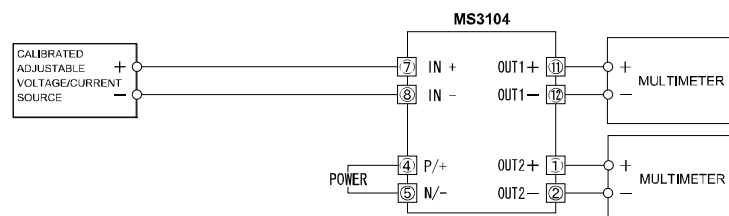

10. Maintenance and Inspection

Check the unit for proper characteristics and settings about once every two years.

11. Warranty Period and Scope

[Warranty Period]

MTT's hardware products are warranted for a period of seven (7) years from the date of shipment.

[Warranty Scope]

- 1) MTT warrants that its hardware products are free from defects in materials and workmanship and conform to its product specifications.
- 2) MTT ships the products under its appropriate quality management system and quality control, but does not warrant, expressed or implied, that the operation, output, or indication of the hardware will be uninterrupted or error free. MTT shall not be liable and make no warranty for any damage to or any safety or performance trouble in the customer's or any other third party's equipment if the operation, output, or indication is interrupted or faulty.
- 3) If, during the warranty period, the product proves to be defective when used in accordance with the relevant user's manual, the product will be repaired or replaced.
- 4) This warranty does not apply to any malfunction or failure resulting from the following:
 - a. Improper or incomplete maintenance or calibration,
 - b. Any other cause, which does not relate with the delivered product,
 - c. Modification or repair by any person other than MTT, and
 - d. Natural disasters or other unavoidable accidents, for which MTT is not liable.