

User's Manual MS3705HB

Slim Plug-In Digital Alarm Setter with Isolated Dual Output (High Accuracy Model)

Document No: MQDDK-130411-1

Rev. 1.50

Thank you very much for employing MTT products.

Upon receipt of the product(s), please check the affixed label to make sure that the specifications shown therein conform to your requirements. If you find any discrepancies and/or any damage on the product(s), please contact MTT or its local representatives.



You can be assured that all the MTT products are manufactured according to the strict quality control standards.

1. Introduction



For proper operation of the instrument(s), we recommend that you carefully read this manual prior to operation. The manual should be retained for future reference. Please also refer to the relevant product specification sheet.

2. For Safe Operation

Be sure to observe the following safety clauses in your operation of the instrument(s). MTT cannot undertake any responsibility and guarantee for any damage and/or loss caused by improper operation contrary to or neglecting these clauses.

 WARNING	Disregard of this clause may cause fatal harm or serious bodily injury due to fire or electric shock.
 CAUTION	Disregard of this clause may cause bodily harm or damages to nearby objects due to electric shock or other accidental happenings.

The following safety symbols are used on the instrument and in this document:

-  Equipment protected throughout by double insulation or reinforced insulation
-  Functional earth terminal (Do not use this as a protective earth terminal.)

WARNING

- All electrical connections must be made to the terminal block of the socket. All connections and disconnections must be made with no power applied to the instrument. Otherwise, electric shock may result.
- Do not disassemble or modify the instrument, and do not replace the power fuse. Otherwise, fire or electric shock could result.
- Do not allow any foreign matter (metal chips, water, liquid, etc.) to get into the instrument. Should any foreign matter enter the instrument, immediately unplug the power cable, and contact MTT or its distributor.
- When the instrument is used for applications that require higher reliability and safety, such as transportation, communication, power generation control and medical equipment, special consideration should be taken in safety design to prevent such equipment from malfunctioning as a whole system.
- Do not operate the instrument in an explosive atmosphere containing flammable vapors, gases or dusts. Otherwise, an explosion may result.
- Do not place any combustible materials in the vicinity of the instrument.
- Because no power switch is provided on the instrument, the power supply of the instrument cannot be turned off on the instrument side. So, be sure to provide a power circuit breaker for the power source of the instrument. Note that the breaker should be installed in a location close to the instrument for the convenience of operation. And the breaker should be marked as a "disconnecting device" for the instrument.

CAUTION

- Use the instrument within the operating conditions described in the published product specification. Failure to do so may cause fire or damage to the instrument.
- Avoid operating the instrument in locations where extreme temperature changes can cause condensation. Otherwise, it may be damaged and malfunction.
- Avoid operating or storing the instrument in locations where corrosive gases are present or chemical solvents may splash.
- Hot-swapping may not cause immediate defects in the unit, but this should be avoided as far as possible.
- For the sake of safety, installation and wiring must be performed by qualified personnel with expertise in electronics, electricity or instrumentation engineering.

3. Precautions

Be sure to observe the following precautions to ensure proper operation of the instrument(s). If these precautions are disregarded, the performance of the instrument(s) cannot be guaranteed.

For Handling:

- This is a precision instrument. Do not drop or throw the instrument.
- This product contains electronic parts. Do not splash water on the product and do not dip it in water. For installation, select a place where no condensation occurs.
- Avoid storing or installing the instrument in locations subject to direct sunlight, high temperature, dust, high humidity or vibration.

On Power Supply:

Check the power rating on the specification label of the unit to ensure you use the correct power supply.

- Rating 100 to 240V AC, 50 to 60Hz, 7.0VA max. (Input range: 85 to 264V AC, 47 to 63Hz)
- Rating 24V DC, 2.2W max. (Input range: 24V DC±10%)
- Rating 100 to 240V DC, 8.4W max. (Input range: 85 to 264V DC)

For Installation:

- The instrument is intended for indoor installation.
- Refer to section 10 "Mounting / Demounting" to install the unit on a DIN rail or wall.
- Operating environmental conditions:
 - Temperature range: -5 to 55°C
 - Humidity: 5 to 90% RH
 - Altitude up to 2000 meters
- Do not block the vents in the instrument.
- Be careful not to ground the minus (-) terminal of the power supply.
- Use an independent grounding or alternative grounding which does not allow current to flow in.
- The instrument should be installed as shown in the sketch below, namely, in such a position that the label on the front panel is readable in the right direction.
- For effective heat dissipation, allow a space of at least 100 mm above and below the unit. When units are used in multiple stacks, they should be spaced at least 130 mm apart from each other. If the required minimum space is not available, take appropriate heat protection measures by, e.g., placing a partition between the units. Provide a ventilation hole or install a cooling fan to improve airflow. Keep adequate working space in front of and on both sides of the unit.

Installation Position

Typical Installation Example

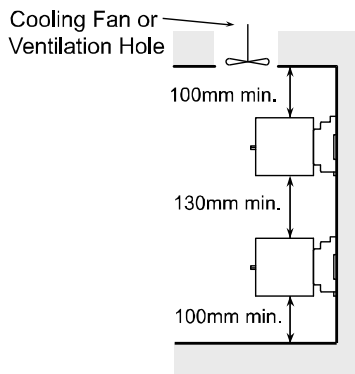
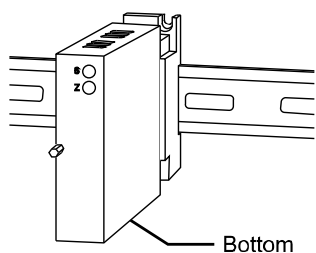

On Wiring:

- Connections to the instrument should be made to the terminal block. For assignment of the terminals, refer to section 6. The recommended screwing torque is 0.8 to 1.0 Nm.
- For lead wires, use a highly flexible stranded conductor. The recommended nominal cross-section of the lead wire conductor is 0.5 to 2.0 mm².
- The connection of the lead wire to the terminal block should be made with the insulated crimp terminal attached to the end of the wire. Without the insulation, short circuit or electric shock may occur. The recommended thickness of the crimp terminal is 0.7 to 1.0 mm.
Note that only up to two (2) crimp terminals can be connected to one (1) terminal screw. In this case, the thickness of the crimp terminal should be not greater than 0.8 mm.

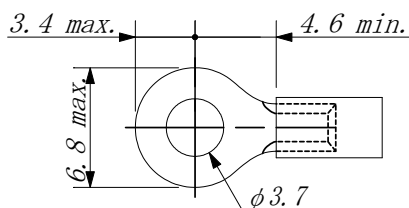

To Avoid Erroneous Measurements:

- In order to reduce the influence of noise, the input/output wire and power supply wire should not be used in a same bundle or same conduit. They should be installed separately with a minimum distance of 200 mm.
- Avoid wiring the signal lines in the vicinity of equipment generating magnetic fields or electromagnetic waves, such as electric motors and large-scale transformers. If inevitable, anti-noise measures such as employment of shielded wires are indispensable.
- At least 30 minutes of warm-up is required prior to operation.
- Any sensor or equipment to be connected to the instrument should be selected in consideration of the input/output impedance of the same. (For detailed specifications, refer to section 4 or the relevant product specification sheet that can be downloaded from our website at <https://www.mtt.co.jp>.)

4. About the Product

The MS3705HB compares the levels of DC current or voltage signals with two set-points selected using front panel switches and outputs two independent isolated relay contact closure signals.

Features:

- Manual setting by front panel switches, enabling any set-point within the range of 0 to 105% (in 0.1% steps; but in 1% steps for the range over 100%).
- Relay activation mode and hysteresis settings are possible with the front panel switches. (Four activation modes are available. For details, refer to the figures on the following page.)
- Pin and socket contacts are gold-plated (0.2μm) to ensure high reliability and long-term stability.
- High dielectric strength of 2,000 VAC between input, [output 1, output 2], power, and ground.
- The power unit can deliver AC power ranging from 85 to 264V steplessly without switching to meet varied power requirements.
- Plug-in type for better maintainability
- Drop-proof terminal screws for ease and safety of installation
- Fuse installed in the power line as standard.

Specifications

Input Resistance	Voltage input: 1MΩ min. with or without power. Current input: 250Ω (Standard for 4-20mA DC)
Allowable Input Voltage	Voltage input: 30V DC max., continuous. (Standard for a span up to 10V) Current input: 40mA DC max., continuous. (Standard for 4-20mA)
Output	Two independent form C relay contact closure signals
Trip Points	Setting: Through the front-accessible setting switches. Range: 0 to 105% of span (in 0.1% steps; in 1% steps for the range over 100%) Accuracy: Better than ±0.1% of span Hysteresis: 0.5 to 50% of span Hysteresis accuracy: ±0.1% of span Note: The upper and lower hysteresis limits are respectively 110% and -10% of span.
Relay Status Indicator LED	Red LED lights up when the relay is activated.
Relay Activation without Power	COM and NC are closed for each output.
Relay Start-up Limitation	The relay gets ready for action 2 seconds after power-up.
Temperature Effect	Better than ±0.15% of span per 10°C change in ambient.
Response Time	150ms max. (0-90%) with a step input at 100%.
Insulation Resistance	100MΩ min. (@ 500V DC) between input, output 1, output 2, power, and ground.
Dielectric Strength	Input / Output 1 / Output 2 / [Power, Ground]: 2000V AC for 1 minute (Cutoff current: 0.5mA) Power / Ground: 2000V AC for 1 minute (Cutoff current: 5mA)
Relay Contacts	Rated load: 5A 125VAC, 5A 30VDC Maximum allowable voltage: 250VAC, 30VDC Maximum allowable current: 5A (NO) / 3A (NC) Electrical life: 5A 250VAC (NO): 50×10 ³ cycles (Frequency: 1,800 cycles/h) 5A 30VDC (NO): 100×10 ³ cycles (Frequency: 1,800 cycles/h) Mechanical life: 5×10 ⁶ cycles (Frequency: 18,000 cycles/h)
Surge Withstand Capability	Tested as per ANSI/IEEE C37.90.1-1989.
Storage Temperature	-10 to 60°C

Upper Limit Alarm (Relay activated/deactivated by alarm condition)

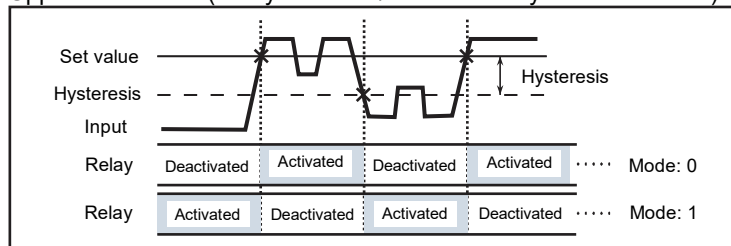

Lower Limit Alarm (Relay activated/deactivated by alarm condition)

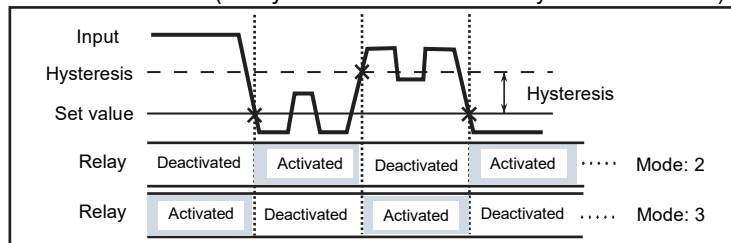

5. External Dimensions & Terminal Assignments

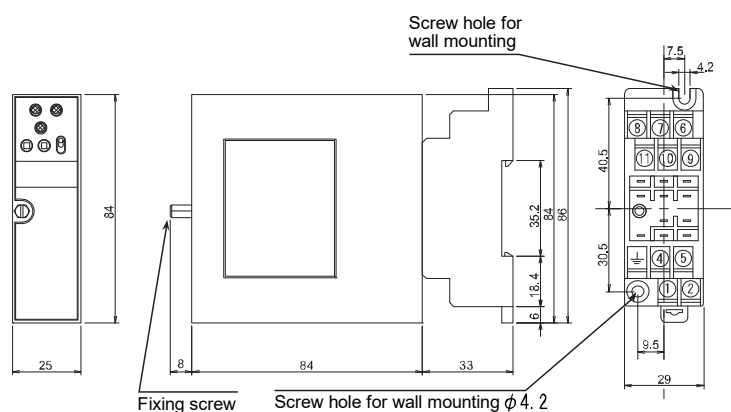

6. Terminal Connection Diagram

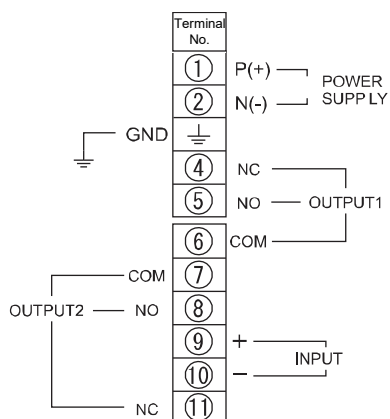

7. Terminal Connection

The following steps should be taken prior to the connection.

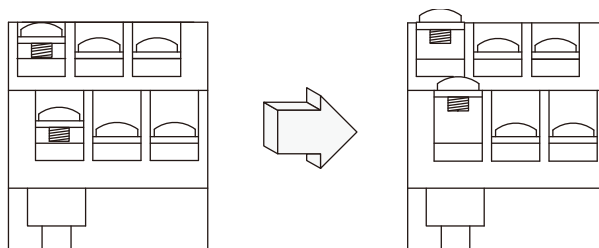

- (1) Loosen the terminal screw.
- (2) Insert the tip of a screwdriver bit beneath the washer and push it up to make ample room to receive a cable.

8. Output Connection

When connecting an inductive load, such as an electric motor, to the output, connect a relay contact protection circuit across the load as shown below.

When AC-powered:

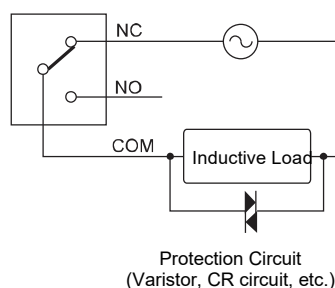

When DC-powered:

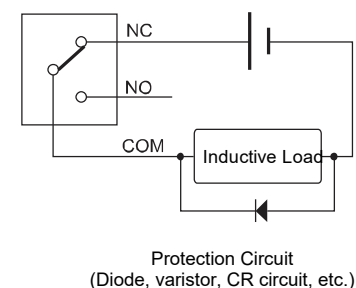

9. Power Line Connection

The terminals for power supply connection (① and ②) are covered with a plastic plate for safety (see Fig. 1).

Open the cover plate and connect the power lines to the terminals (see Fig. 2).

Return the cover plate to its original position (see Fig. 3).

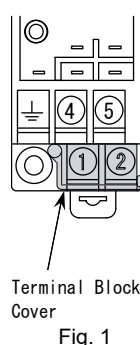

Fig. 1

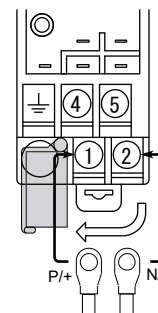

Fig. 2

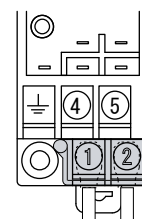
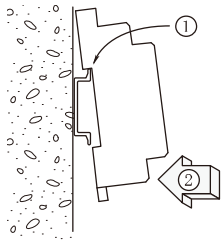

Fig. 3

Note: For your safety, do not make any electrical connections or disconnections with power supplied to the instrument. Make sure that all terminal screws are properly tightened each time you finish the tightening.

10. Mounting / Demounting

Mounting the Socket on a DIN rail



Hold the socket with the slide clamp facing down. Hook the upper edge of the cavity in the rear of the socket over the upper blade of the rail (①), then push the lower part of the socket against the lower blade of the rail so as to make the slide clamp engaged firmly with the rail (②).

Demounting the Socket

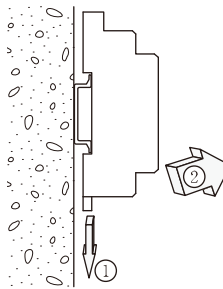

Push the slide clamp downward with a flat-head screwdriver bit or the like (①), and pull the lower part of the socket toward you (②).

Main Unit Installation / Removal

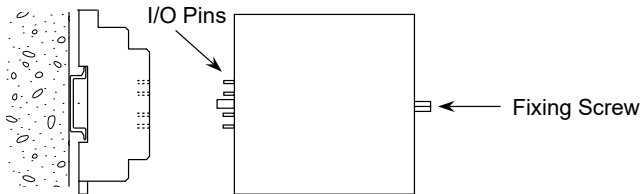

Installation

- Identify the top and the bottom of the unit and insert the I/O pins straight into the corresponding pin slots (receptacles) on the socket.
- Tighten the fixing screw to fix the unit firmly in position.

Removal

- Loosen the fixing screw.
- Pull out the unit carefully not to bend the I/O pins.

11. Settings

11-1 Trip Point Setting

Setting for OUT-1:

Set the OUT-1/2 Selector Switch to the RY1 position, and the Relay Trip Point Indicator will show the current trip point value for OUT-1. You can use the UP or DOWN Switch to change the value.

Setting for OUT-2:

Set the OUT-1/2 Selector Switch to the RY2 position, and the Relay Trip Point Indicator will show the current value for OUT-2. You can similarly change the value.

Note: If no switch is operated for one minute, the indicators will automatically turn off. To turn the unlit indicators back on, press the UP or DOWN switch or move the OUT-1/2 Selector Switch to the opposite position. The Relay Trip Point Indicator and CPU Status Indicator will blink as shown in the table (#1) in section 12, and then the former indicator will show the current value.

11-2 Mode Setting

Turn on the power while holding down the DOWN Switch. After the CPU Status Indicator LED starts blinking, release the DOWN Switch. The Relay Trip Point Indicator will show the current relay activation mode for the output you have selected with the OUT-1/2 Selector Switch, i.e., OUT-1 when it is in the RY1 position and OUT-2 when in the RY2 position. You can use the UP or DOWN Switch to change the mode, referring to the table below. To make your change take effect, move the OUT-1/2 Selector Switch to the opposite position to where it is located. This enables the instrument to save the setting. After completing the setting, cycle the power to start operation in the mode you have selected.

Mode	Output
0	Upper limit alarm; relay activated when alarmed.
1	Upper limit alarm; relay deactivated when alarmed.
2	Lower limit alarm; relay activated when alarmed.
3	Lower limit alarm; relay deactivated when alarmed.

11-3 Hysteresis Setting

Turn on the power while holding down the UP Switch. After the CPU Status Indicator LED starts blinking, release the UP Switch. The Relay Trip Point Indicator will show the current hysteresis value for the output you have selected with the OUT-1/2 Selector Switch, i.e., OUT-1 when it is in the RY1 position and OUT-2 when in the RY2 position. You can use the UP or DOWN Switch to change the hysteresis value. To make your change take effect, move the OUT-1/2 Selector Switch to the opposite position to where it is located. This enables the instrument to save the setting. After completing the setting, cycle the power to start operation based on the hysteresis you have set.

Notes:

- The UP/DOWN switch is of a push button type. Pressing and holding the switch changes the value faster.
- Unless otherwise requested, the relay operation will be set to the factory default settings shown in the table below.

Output	Trip Point	Mode	Hysteresis
OUT-1	50%	0	1.0%
OUT-2	50%	2	1.0%

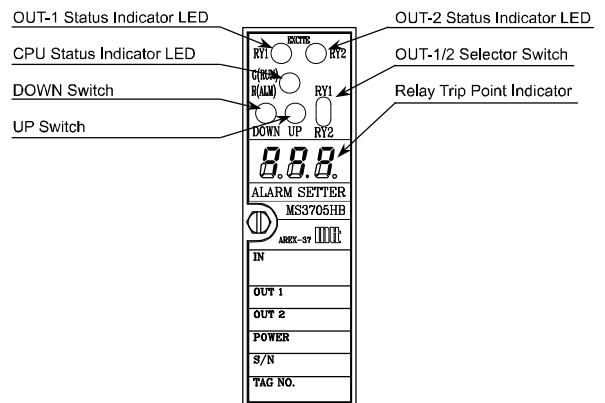

12. LED Status Indicator

The MS3705HB has LED indicators to indicate its status. The following table shows indicator patterns.

No	Event	Relay Trip Point Indicator	CPU Status Indicator	Relay	Recovery Operation
1	Power ON or switch operation	Blinks 3 times (1s ON - 0.5s OFF cycle).	Green LED turns ON for 1 second, and then red LED turns ON for 0.5 second. This cycle is repeated 3 times.	Normal operation	-
2	Normal operation	OFF	Green LED is ON.	Normal operation	-
3	Trip Point setting	Set value	Green LED is ON.	Normal operation	-
4	Hysteresis / Mode setting	Set value	Green LED blinks at 1 second intervals.	Deactivated	-
5	Data error in Relay Trip Point setting	02	Red LED blinks at 1 second intervals.	Deactivated	Reconfiguration
6	Data error in Relay Start-up Limitation	04	Red LED blinks at 1 second intervals.	Deactivated	Reconfiguration
7	Data error of a compensated value	08	Red LED blinks at 1 second intervals.	Deactivated	None
8	Data error in Hysteresis Setting	16	Red LED blinks at 1 second intervals.	Deactivated	Reconfiguration
9	Data error in Relay Activation Mode Setting	32	Red LED blinks at 1 second intervals.	Deactivated	Reconfiguration
10	System error	Not defined.	Red LED is ON; Green LED is not defined.	Deactivated	None

Notes:

#1: When the Relay Trip Point Indicator is turned on, a 3-digit number "888" with dots is displayed.

#5-9: Only the last 2 digits are displayed in the event of an error.

#10: The red LED may fail to light up. The relay operation may sometimes be unstable.

13. Maintenance and Inspection

Check the unit for proper characteristics and settings about once every two years.

14. Warranty Period and Scope

[Warranty Period]

MTT's hardware products are warranted for a period of seven (7) years from the date of shipment.

[Warranty Scope]

- 1) MTT warrants that its hardware products are free from defects in materials and workmanship and conform to its product specifications.
- 2) MTT ships the products under its appropriate quality management system and quality control, but does not warrant, expressed or implied, that the operation, output, or indication of the hardware will be uninterrupted or error free. MTT shall not be liable and make no warranty for any damage to or any safety or performance trouble in the customer's or any other third party's equipment if the operation, output, or indication is interrupted or faulty.
- 3) If, during the warranty period, the product proves to be defective when used in accordance with the relevant user's manual, the product will be repaired or replaced.
- 4) This warranty does not apply to any malfunction or failure resulting from the following:
 - a. Improper or incomplete maintenance or calibration,
 - b. Any other cause, which does not relate with the delivered product,
 - c. Modification or repair by any person other than MTT, and
 - d. Natural disasters or other unavoidable accidents, for which MTT is not liable.